

**ALTERA**®



**SOPC**

**WORLD**

2 0 0 2



**SOPC**  
**WORLD**  
2 0 0 2

# Quartus II 2.1 (LogicLock/Timing Closure)

# Agenda

- Timing Closure Flow
- Netlist Optimization
- Design Analysis
- Timing Closure Assignments
- Summary

# What is Timing Closure?

**A Concept!**

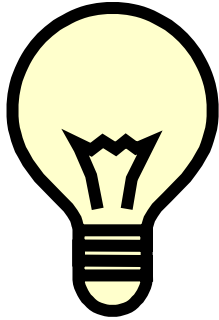

**Way to Achieve  
Timing Requirements  
on a Design!**

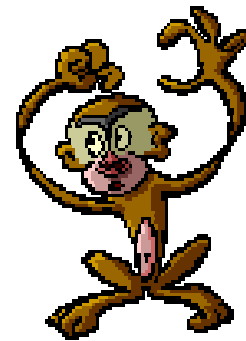

# What Does Quartus II Version 2.1 Offer?

- New Tools to Help Achieve Timing Closure
  - Timing Closure Floorplan
  - Netlist Optimization Options
  - Path-Based Assignments

# Timing Closure Flow

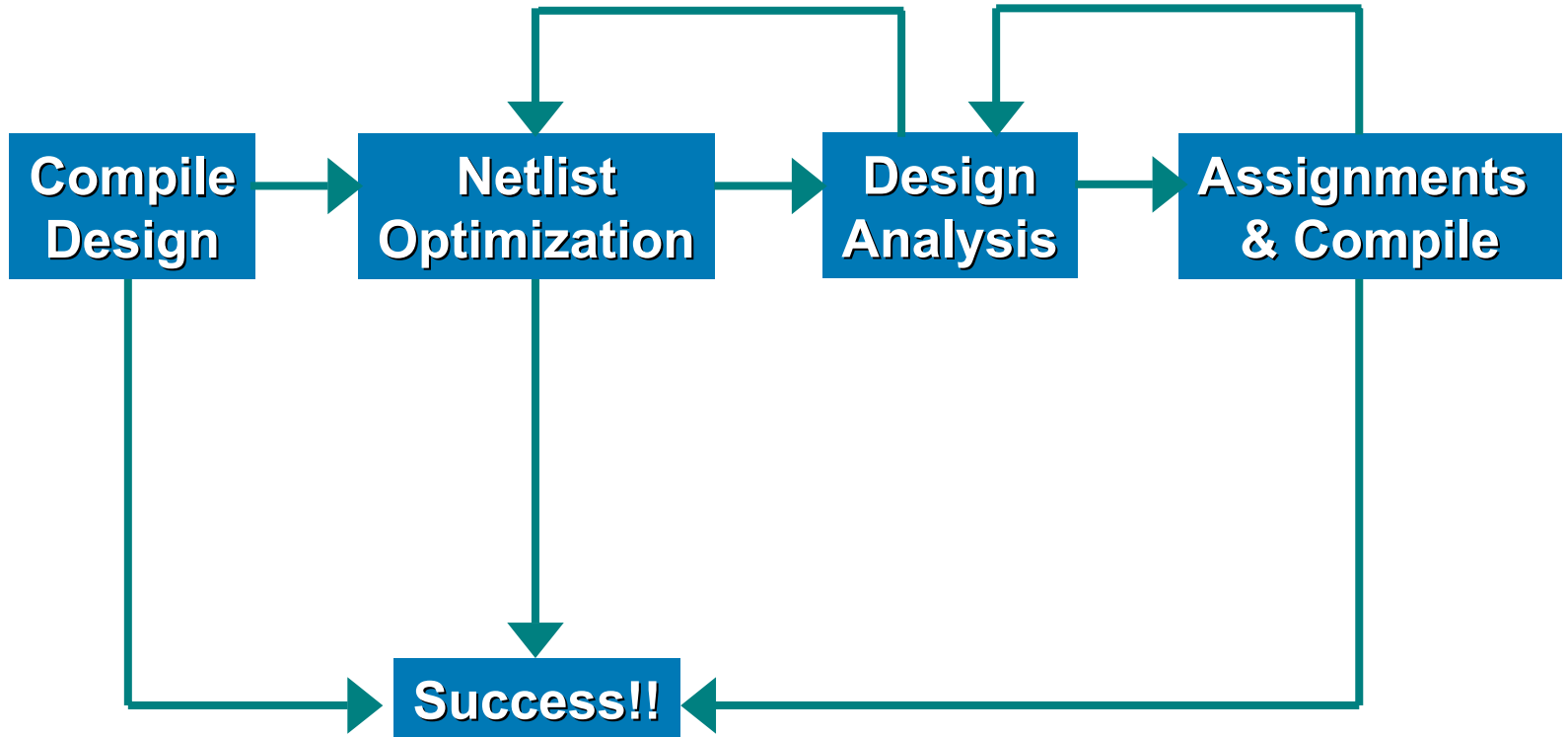

# Netlist Optimization Options

- WYSIWYG Primitive Resynthesis
- Gate-level Register Retiming
- Retiming Trade-Off With  $T_{su}/T_{co}$
- Logic Element Duplication

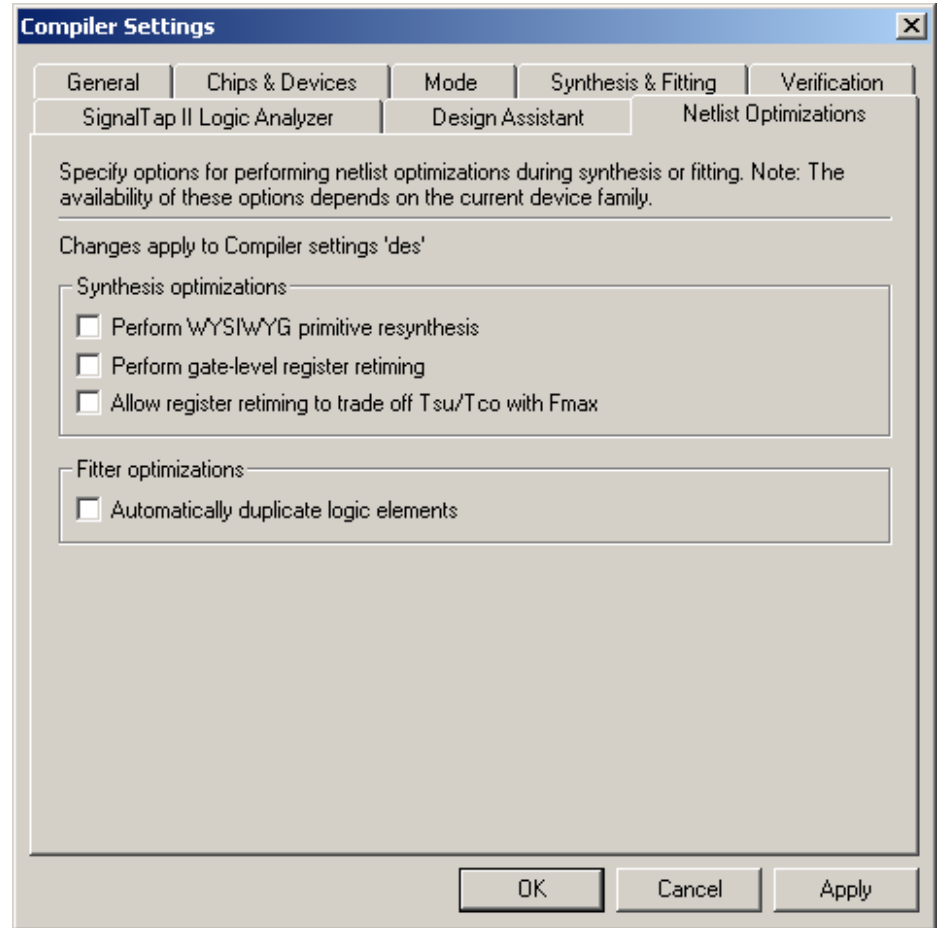

# WYSIWYG Primitive Resynthesis

- Used with Atom NetlistFrom 3<sup>rd</sup> Party Tool
- Unmaps Altera Primitives to Gates & Then Remaps
- Option Not Available When Using Native Synthesis

*Why?*

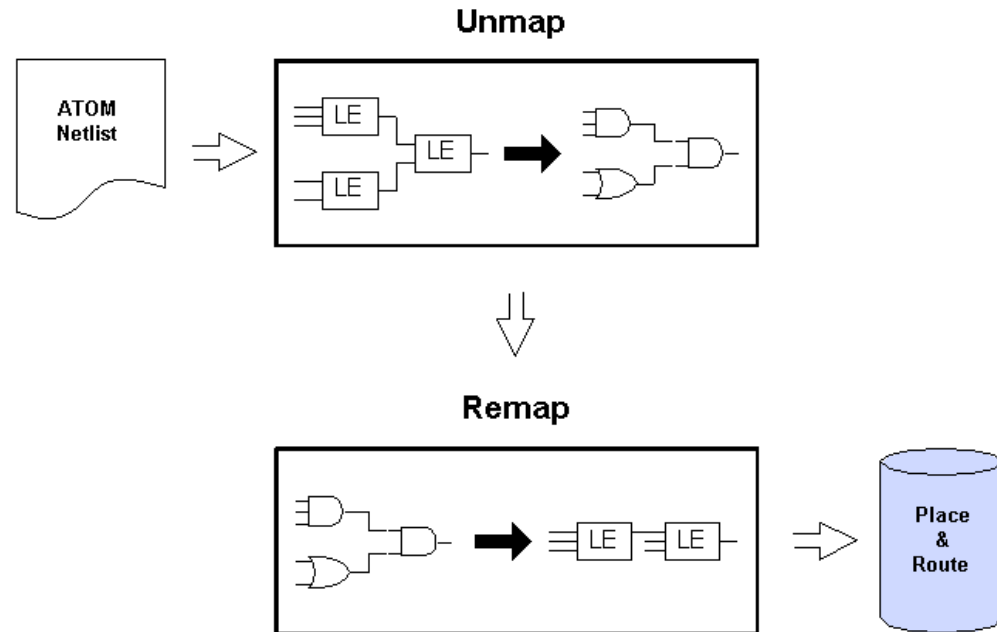



# Gate-Level Register Retiming

- Moves Registers across Combinatorial Logic to Balance Timing
- Trades off Between Critical & Non-Critical Paths
- Changes at Gate Level

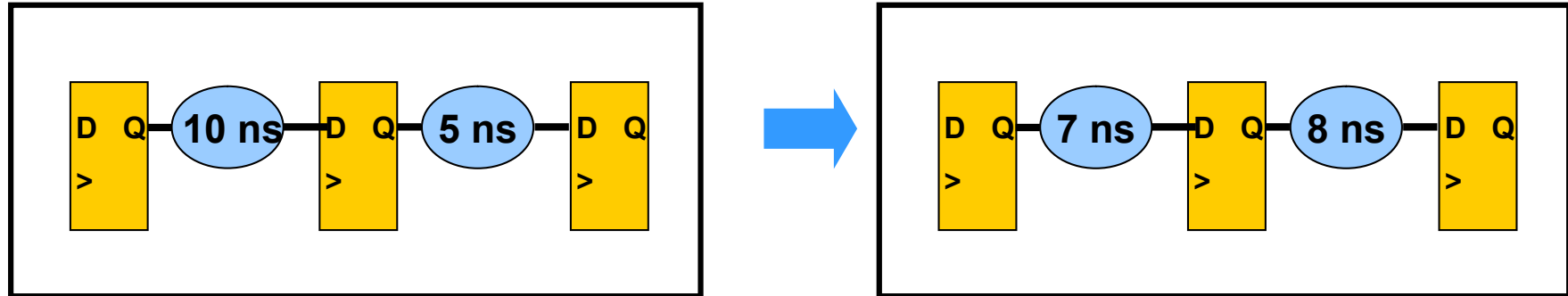

# Gate-Level Register Retiming

- Must Use WYSIWYG Primitive Resynthesis Option if Using an ATOM Netlist
- Why?*
- Must Happen at Gate Level!

VHDL/Verilog Source



ATOM Netlist



# Gate-Level Register Retiming

- Options Allows Registers to Be Combined If

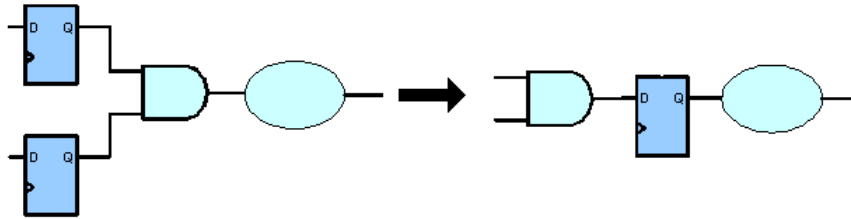

- All Registers Have Same Clock
- All Registers Have Same Clock Enable
- All Registers Same Asynchronous Control Signals
- Only One Register Has Asynchronous Load Other than VCC or GND

# Gate-Level Register Retiming

- List of Registers Created & Removed in Compilation Report

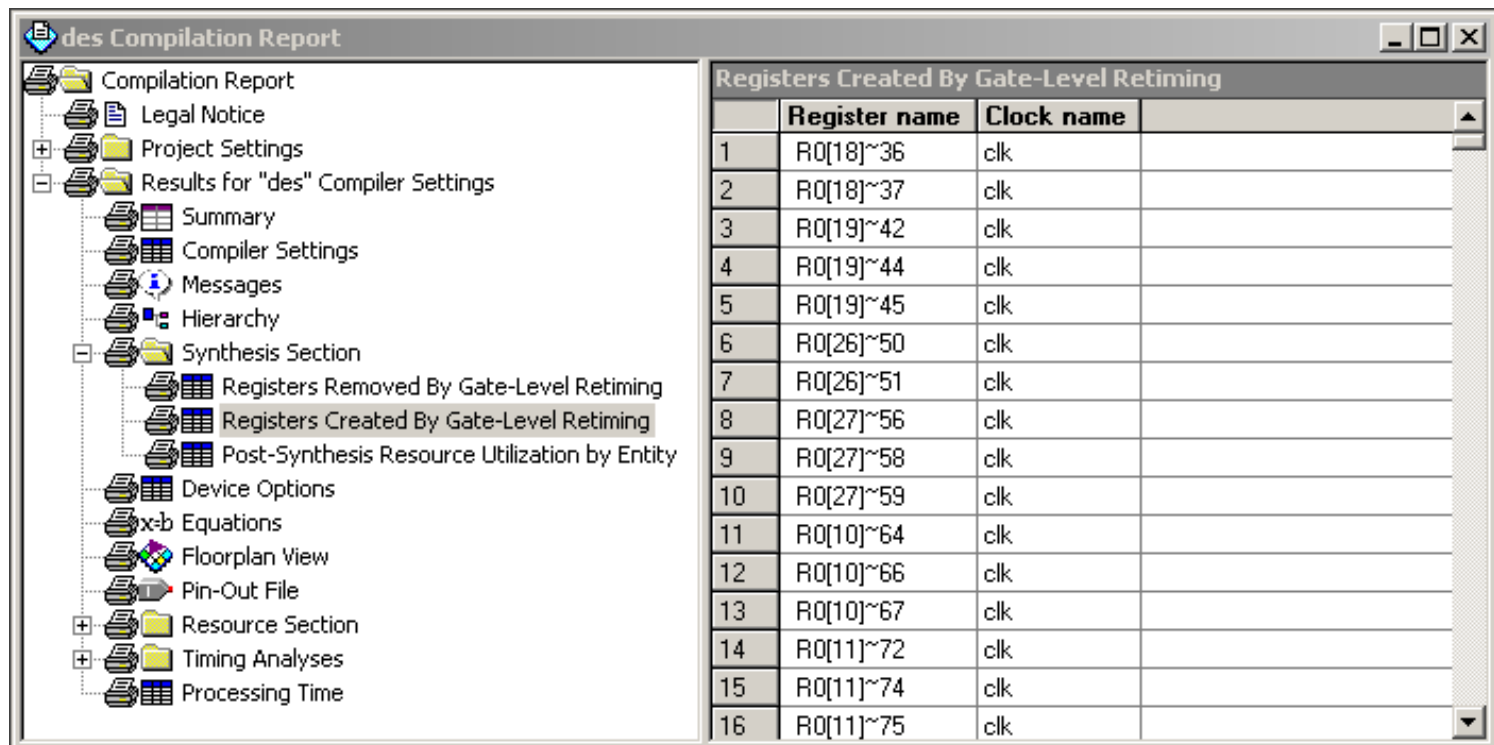

The screenshot shows a software window titled "des Compilation Report". On the left is a tree view of the report's contents, including folders for "Compilation Report", "Project Settings", "Results for 'des' Compiler Settings", "Synthesis Section", "Resource Section", "Timing Analyses", and "Processing Time". Under "Synthesis Section", there are sub-items for "Registers Removed By Gate-Level Retiming", "Registers Created By Gate-Level Retiming", and "Post-Synthesis Resource Utilization by Entity".

The right pane displays a table titled "Registers Created By Gate-Level Retiming". The table has three columns: "Register name", "Clock name", and an empty column. It lists 16 registers, each with a unique name and a common clock name "clk".

	Register name	Clock name	
1	R0[18]~36	clk	
2	R0[18]~37	clk	
3	R0[19]~42	clk	
4	R0[19]~44	clk	
5	R0[19]~45	clk	
6	R0[26]~50	clk	
7	R0[26]~51	clk	
8	R0[27]~56	clk	
9	R0[27]~58	clk	
10	R0[27]~59	clk	
11	R0[10]~64	clk	
12	R0[10]~66	clk	
13	R0[10]~67	clk	
14	R0[11]~72	clk	
15	R0[11]~74	clk	
16	R0[11]~75	clk	

# Logic Element Duplication

- Allows LEs that Fan Out to Multiple Locations to Be Duplicated
- Based on Fitter Information

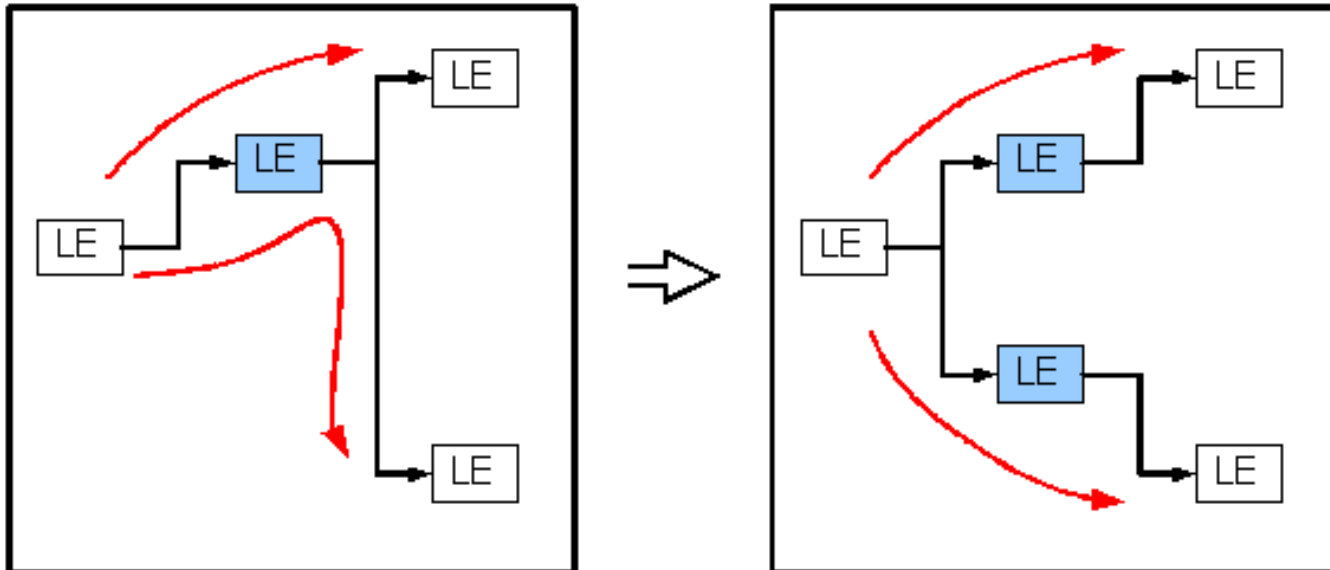

# Netlist Optimization Options

## ■ With Third Party Atom Netlist

1. No Netlist Optimizations Turned On
2. WYSIWYG Primitive Resynthesis Turned On
3. WYSIWYG Primitive Resynthesis & Gate-Level Register Re-timing Turned On
4. Logic Element Duplication Turned On
5. All Three Turned On

## ■ Quartus<sup>®</sup> II Native Synthesis

1. No Netlist Optimizations Turned On
2. Gate-level Register Re-timing Turned On
3. Logic Element Duplication Turned On
4. Gate-Level Register Re-Timing & Logic Element Duplication Turned On

# Design Analysis

- After Compiling, Need to Analyze Design
- Two Common Ways We Do So
  - Timing Analysis Report
  - Floorplans
    - Current Assignments
    - Last Compilation
    - Timing Closure
- We Will Focus on the New Timing Closure Floorplan

# Timing Closure Floorplan

- Floorplan Views
  - Field View **New**
  - Interior Cells
  - Package Top
  - Package Bottom
- Viewing Assignments
- Critical Paths
- Physical Timing Estimates
- LogicLock Region Connectivity



# Field View

- Shows Resources

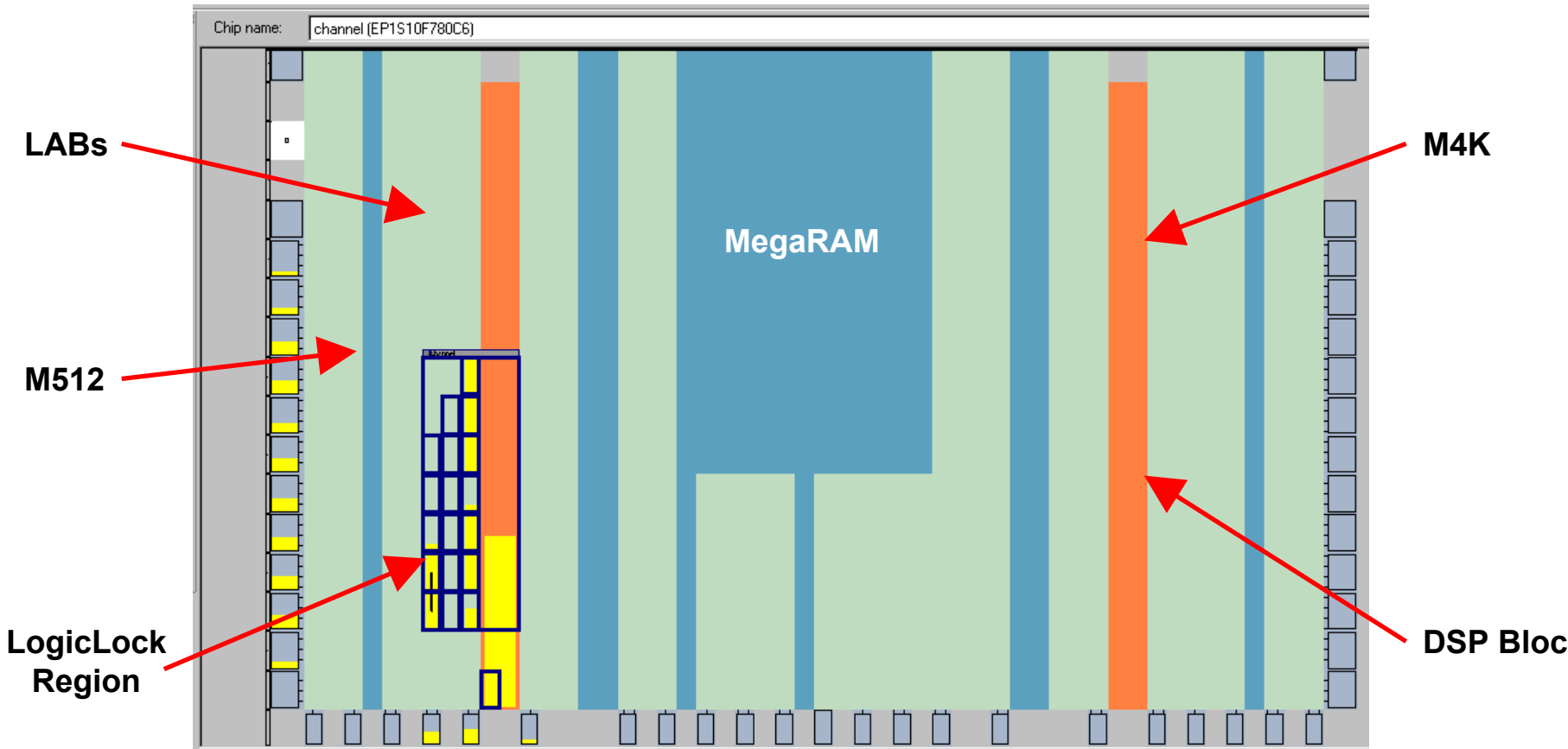

# User Assignments

- Displays Current Assignments
- LogicLock Regions Shown in Navy

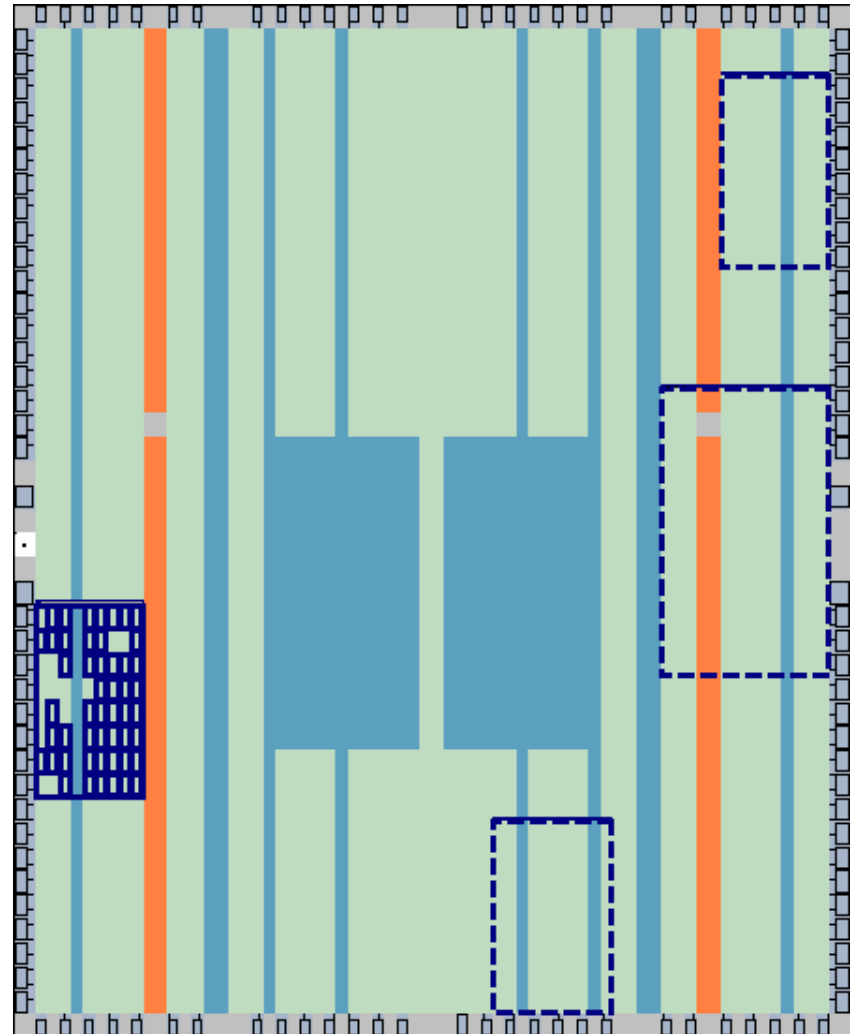

# Fitter Placements

- Displays Last Compilation Assignments
- LogicLock Regions Shown in Magenta

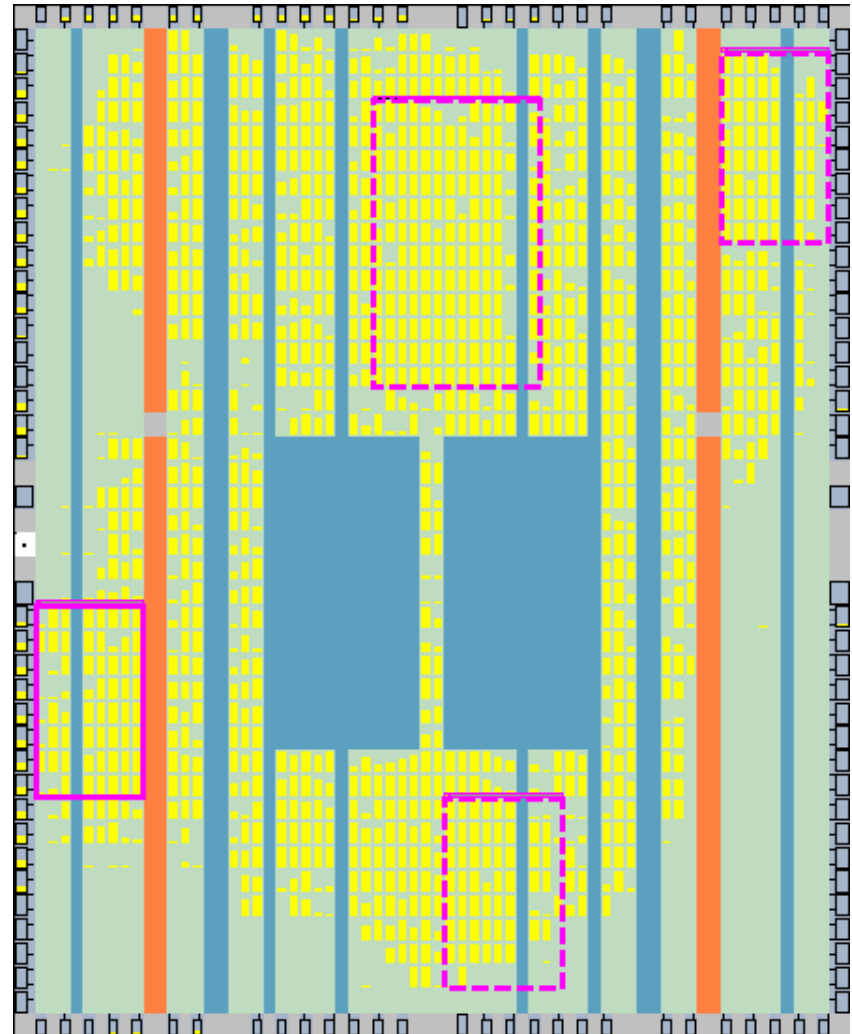

# Viewing Assignments

- Can View User Assignments & Fitter Locations Together

*Why Different  
Region  
Locations?*

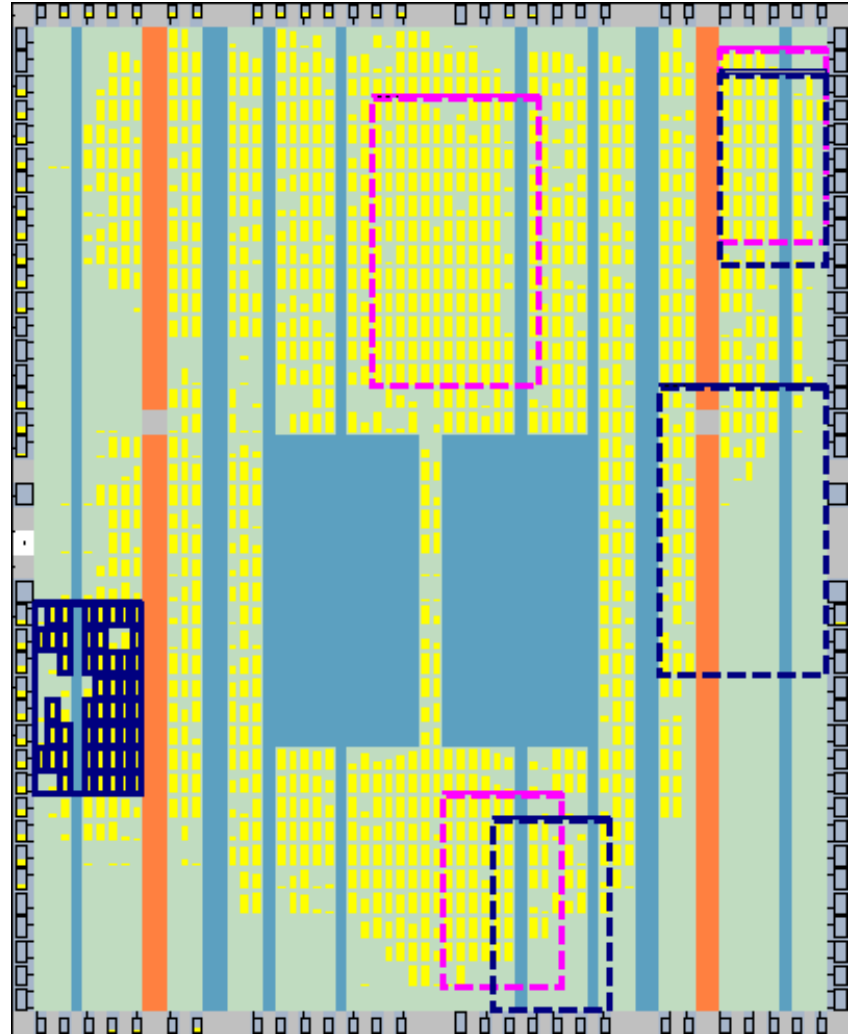

# Critical Paths

- New Utility in Quartus II
- View Paths with Longest Delay
- Can Choose to View
  - A Number of or Percentage of Critical Paths
  - Paths in All Clock Domains or a Specific Clock Domain
  - Type of Paths
    - Pin-to-Pin  $t_{PD}$
    - Pin-to-Register  $t_{SU}$
    - Register-to-Pin  $t_{CO}$
    - Register-to-Register  $F_{MAX}$

*What Do These Types Mean?*

# Critical Path Settings Window

- View -> Routing -> Critical Path Settings
- Critical Path Settings Icon

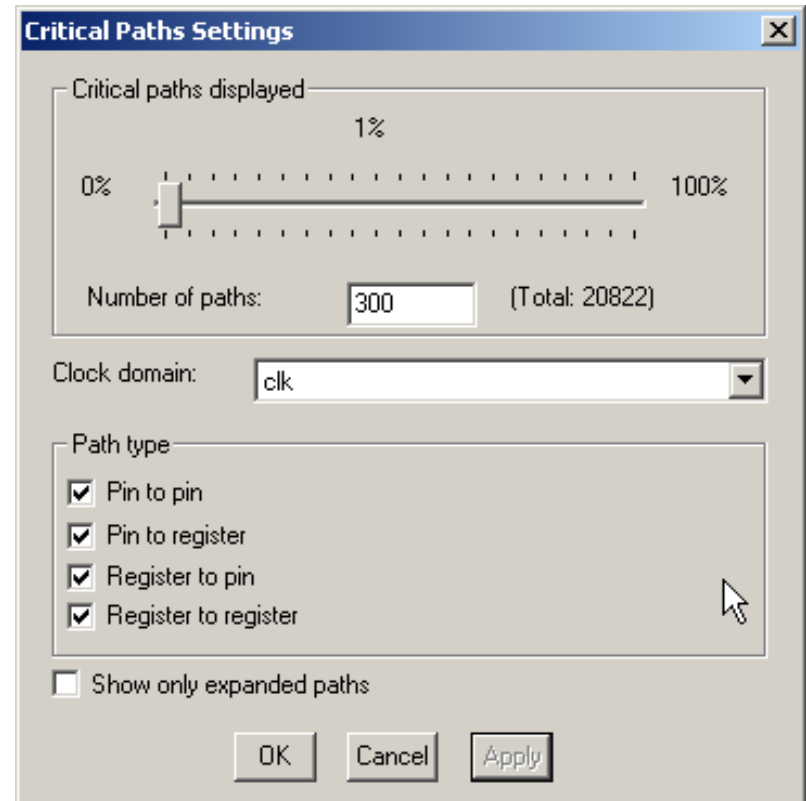
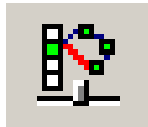

# Critical Paths

- View -> Routing -> Show Critical Path
- Show Critical Paths Icon

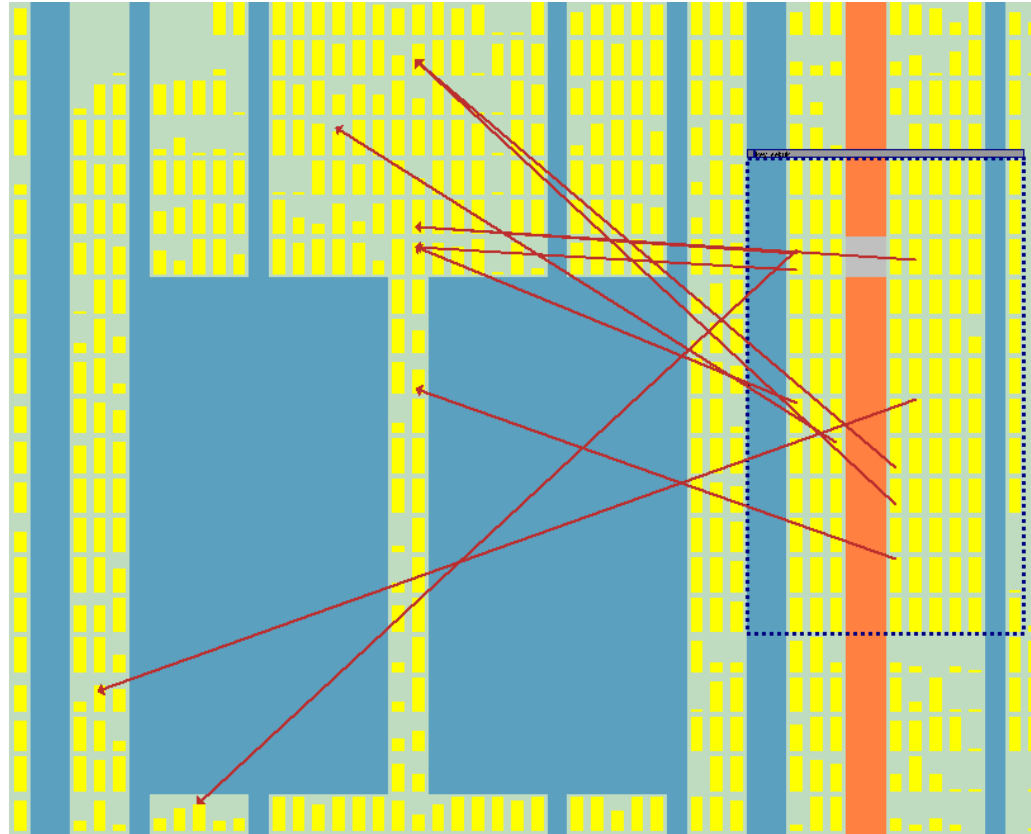
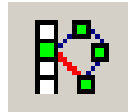

# Critical Path Routing Delays

- Can View Routing Delay of Critical Paths
- View -> Routing -> Show Routing Delays
- Show Routing Delays Icon

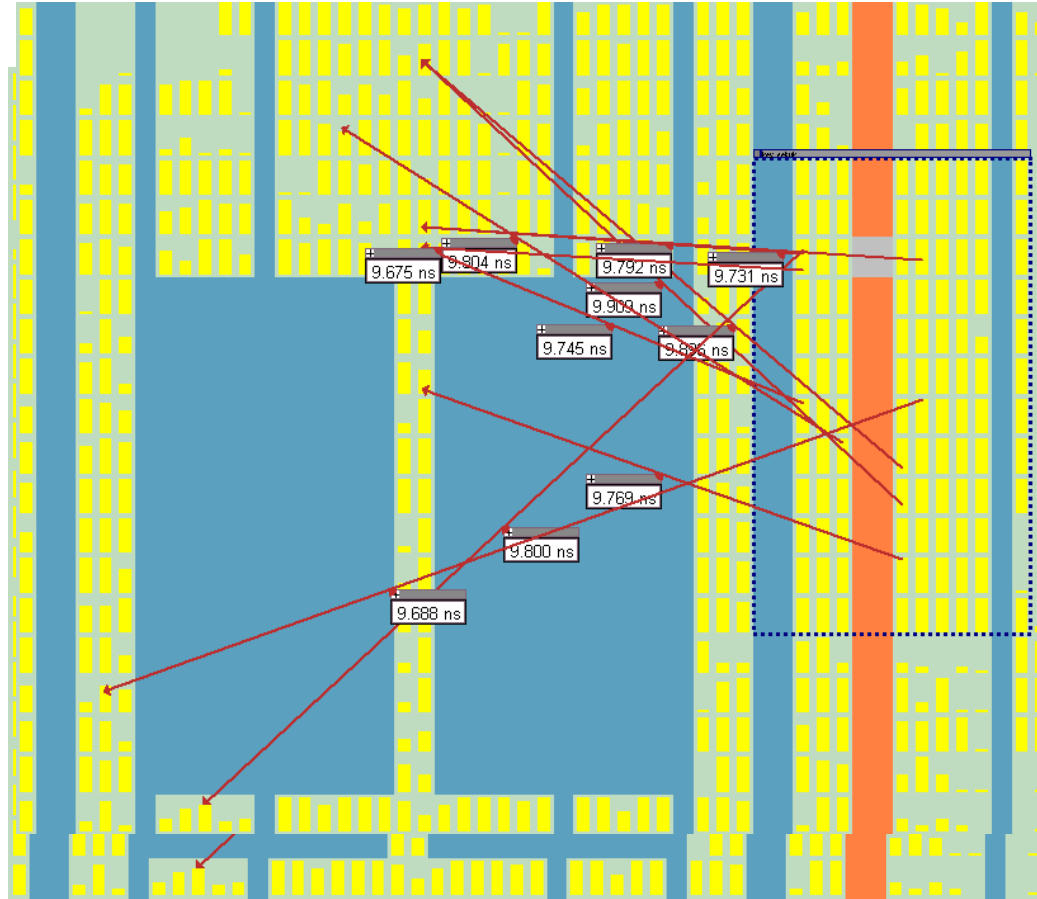
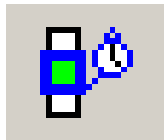



# Show Path Edges

- Shows Worst Case Path Between Registers

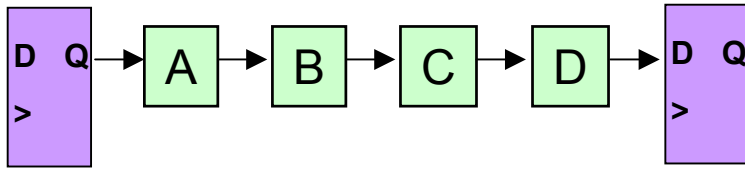

Source

Destination

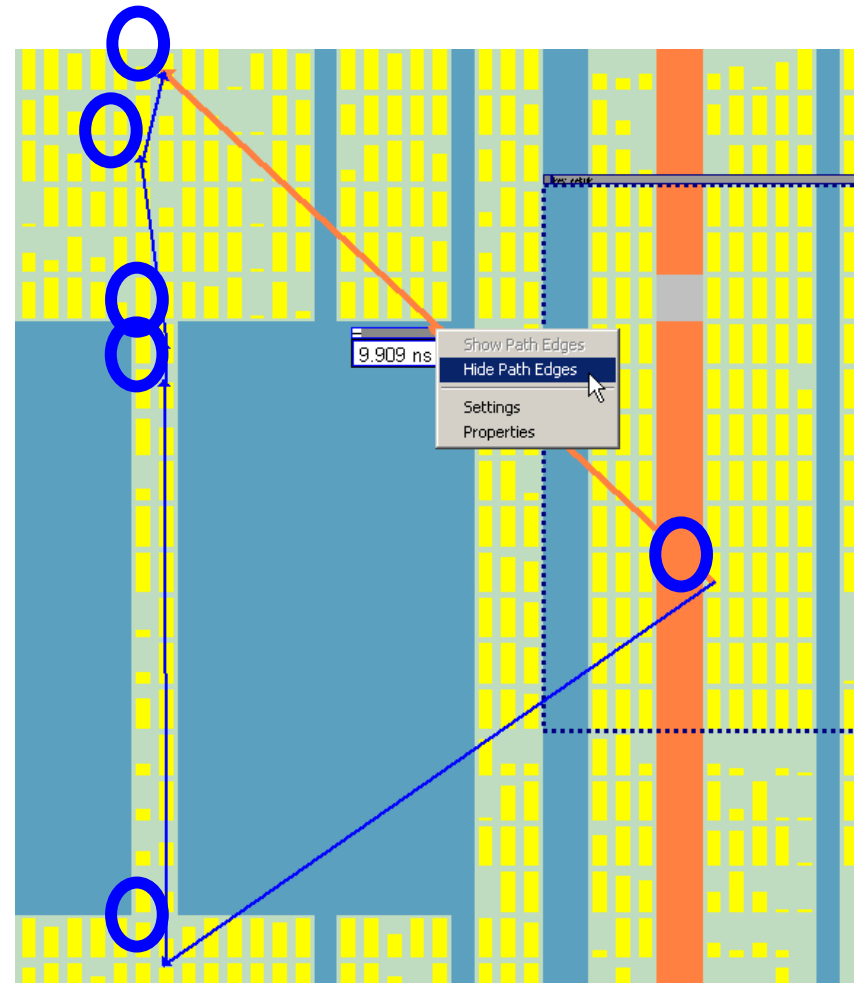

# Max IntraRegion Delay

- Available After Using the Critical Paths Utility Once
- Put Mouse Over LogicLock Region Handle
- Maximum Delay Possible in LogicLock Region

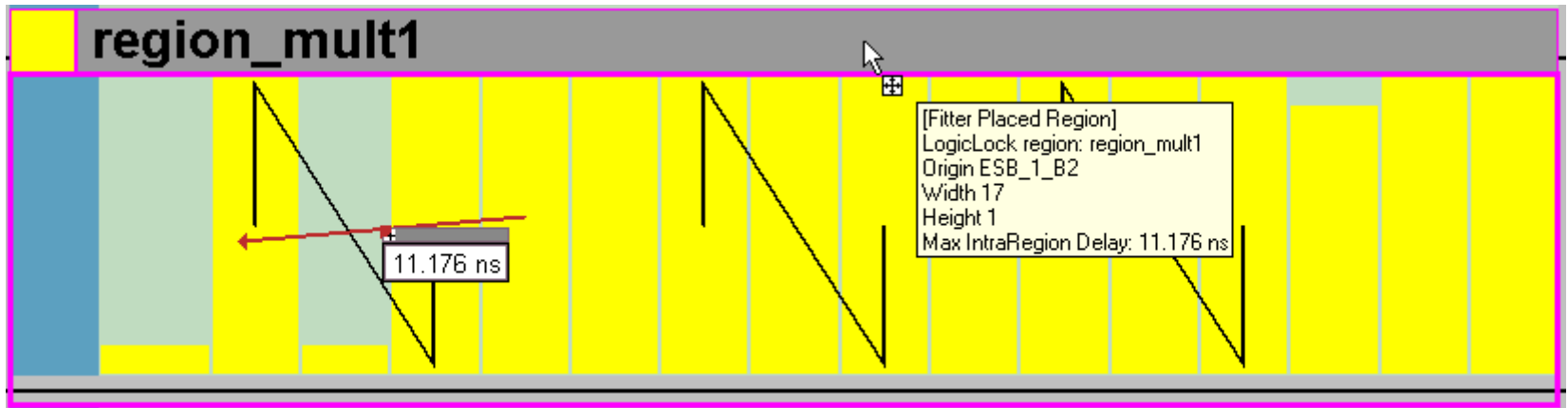

# LogicLock Region Connectivity

- Number of Connections Seen With Thickness of Line
- To See Number of Connections, Select Show Connection Count Icon

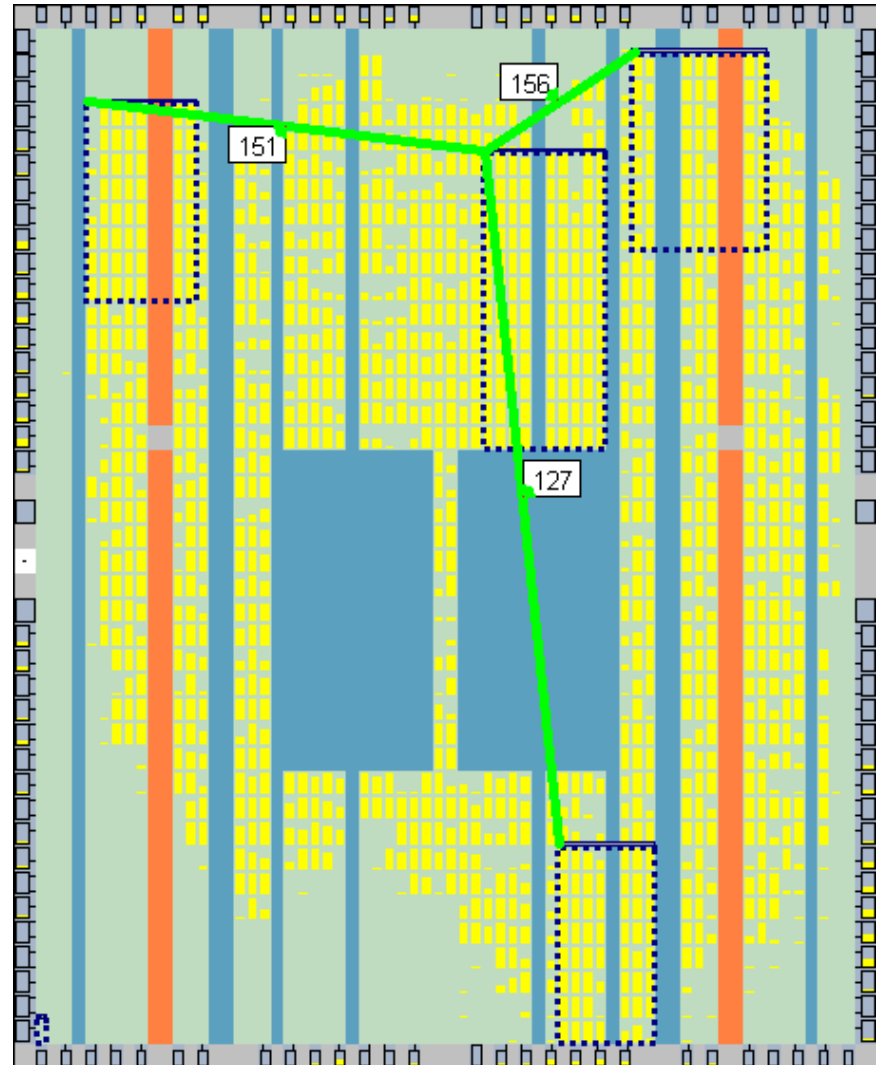
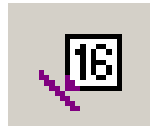

# LogicLock Region Fan-In/Fan-out

- Can See Fan-in & Fan-out of Regions
- Only Nodes with User Assignments Will Be Shown

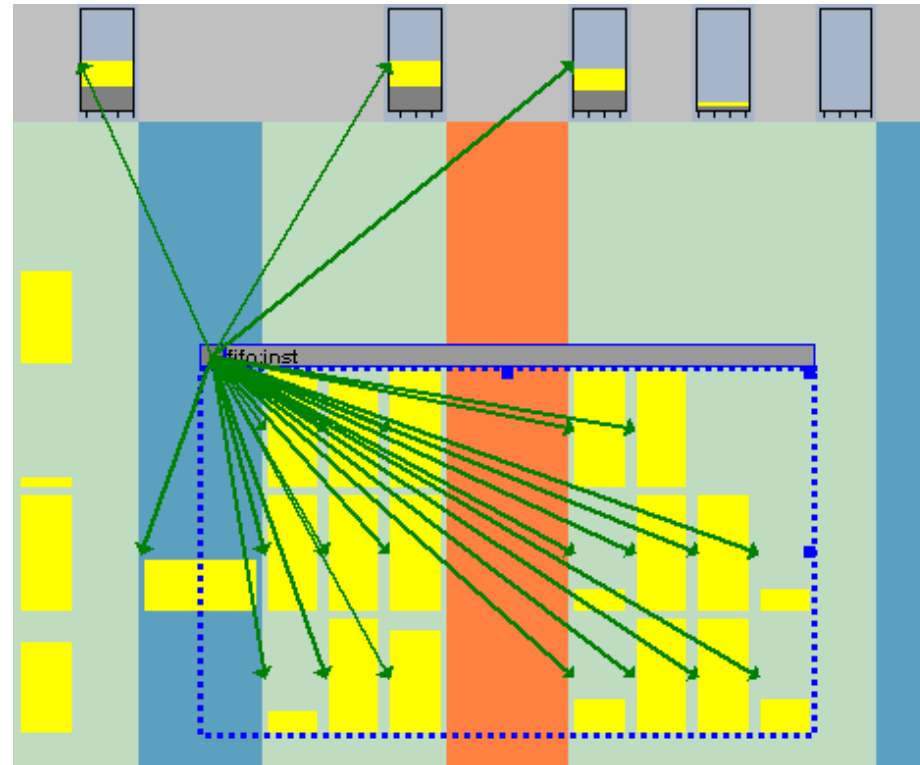

# Timing Closure Assignments

- Quartus II Assignments
  - Location Assignments
  - LogicLock Regions
- Applying Assignments
  - Node Assignments
  - Entity Assignments
  - Path-Based Assignments

# Location Assignments

- Hard Assignments of Nodes to Resources
  - Logic Elements
  - Memory Blocks
  - DSP Blocks
- Can Do Through
  - Assignment Organizer
  - Current Assignments Floorplan
  - Timing Closure Floorplan

# LogicLock GUI

- Quartus II 2.1 Introduces New View for LogicLock
- Comprised of 2 Dialog Boxes
  - LogicLock Regions
  - LogicLock Region Properties
- Tabular, Editable Display of Properties
- Column Display Is Configurable
- Regions with Invalid Properties Shaded Red
  - Repair Region via Context-Menu Entry

# LogicLock GUI

## LogicLock Regions

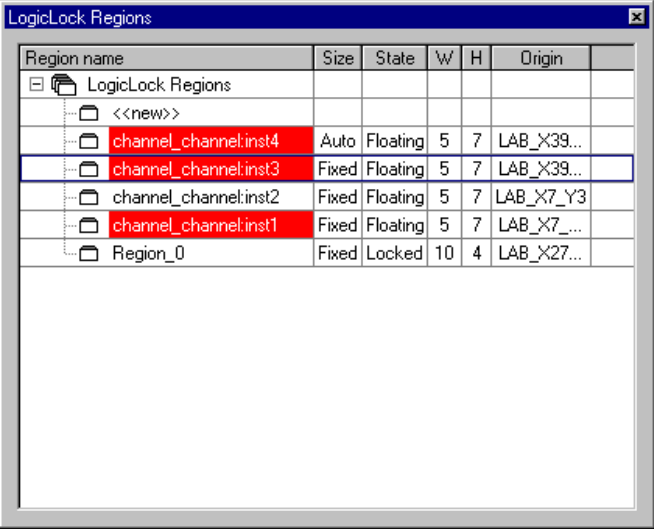

Region name	Size	State	W	H	Origin
LogicLock Regions					
<<new>>					
channel_channel.inst4	Auto	Floating	5	7	LAB_X39...
channel_channel.inst3	Fixed	Floating	5	7	LAB_X39...
channel_channel.inst2	Fixed	Floating	5	7	LAB_X7_Y3
channel_channel.inst1	Fixed	Floating	5	7	LAB_X7_...
Region_0	Fixed	Locked	10	4	LAB_X27...

**Reserve Property**

## LogicLock Region Properties

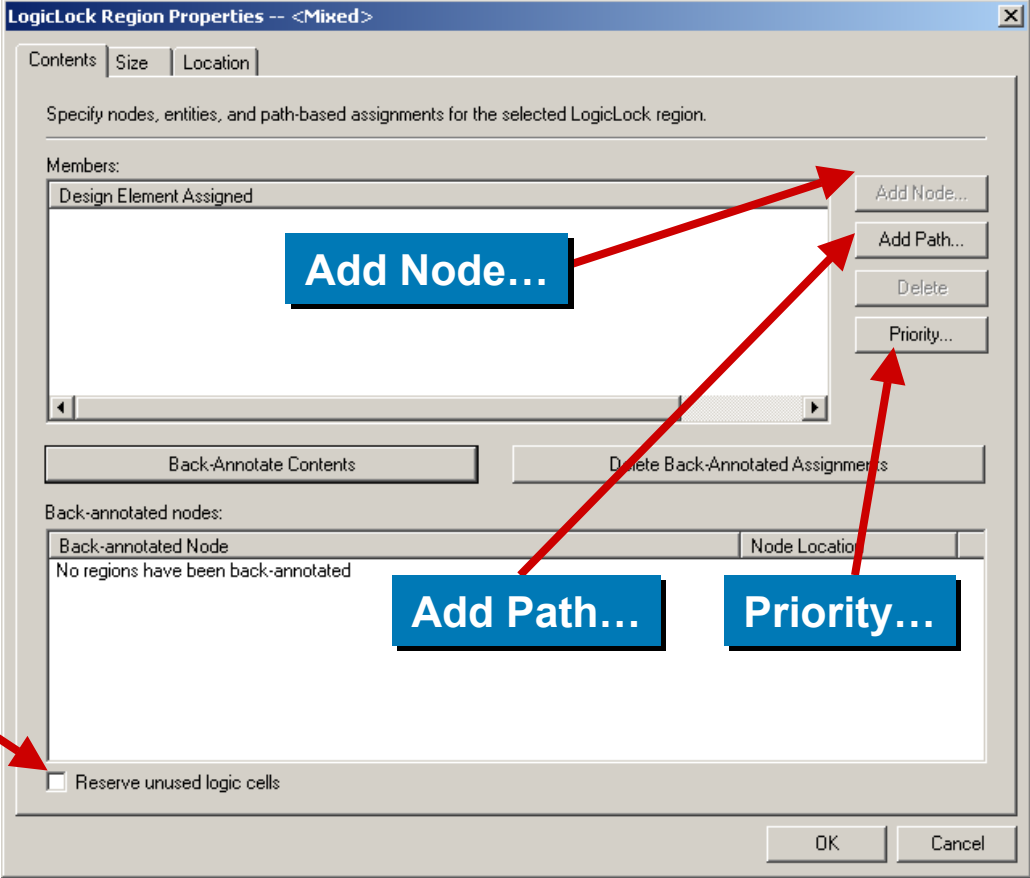

LogicLock Region Properties -- <Mixed>

Contents | Size | Location

Specify nodes, entities, and path-based assignments for the selected LogicLock region.

Members:

Design Element Assigned

**Add Node...** (Annotation)

Add Node...  
Add Path...  
Delete  
Priority...

Back-Annotate Contents | Delete Back-Annotated Assignments

Back-annotated nodes:

Back-annotated Node | Node Location

No regions have been back-annotated

**Add Path...** (Annotation) | **Priority...** (Annotation)

Reserve unused logic cells

OK | Cancel



# Creation Of LogicLock Regions

- Quartus II Version 2.1 Provides 4 Methods to Create LogicLock Regions
  - Using The LogicLock Regions Dialog Box
  - Using The Floorplan Editor
  - Using The Hierarchy Window
  - Using A Tcl Script

# Soft LogicLock Regions

- LogicLock Regions Are Defined With A Hard Rectangular Boundary
- Soft LogicLock Regions Removes The Hard Boundary
  - Quartus II Has The Ability to Remove Nodes Within a LogicLock Region That Has Been Declared Soft

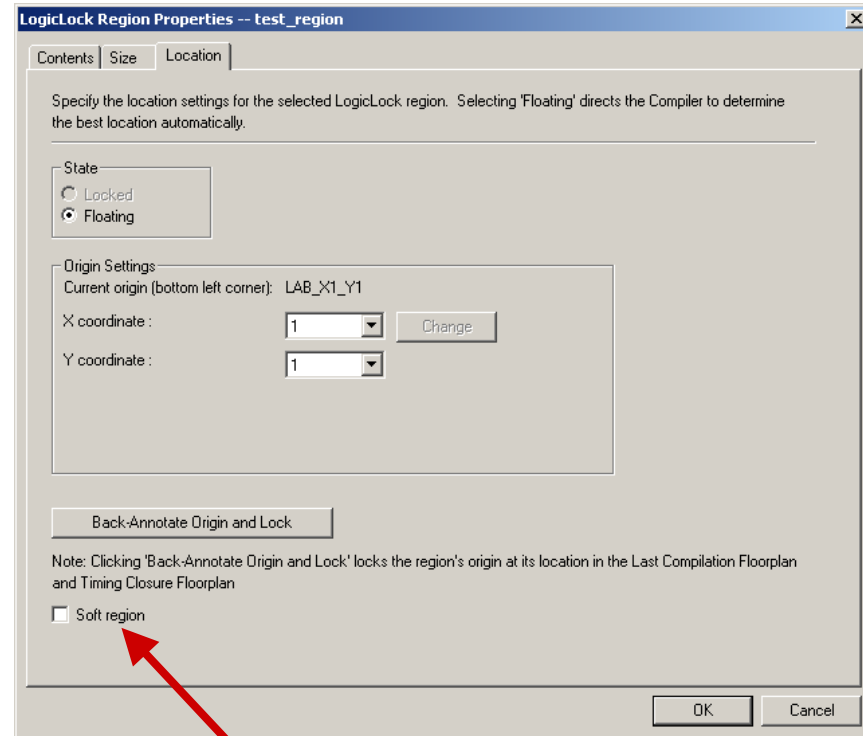

Soft Region

# Soft LogicLock Regions

- An Arbitrary Hierarchy Can Be Applied to Soft LogicLock Regions
- Soft LogicLock Regions Will Remain Within The Boundaries of The First Non-Soft Region

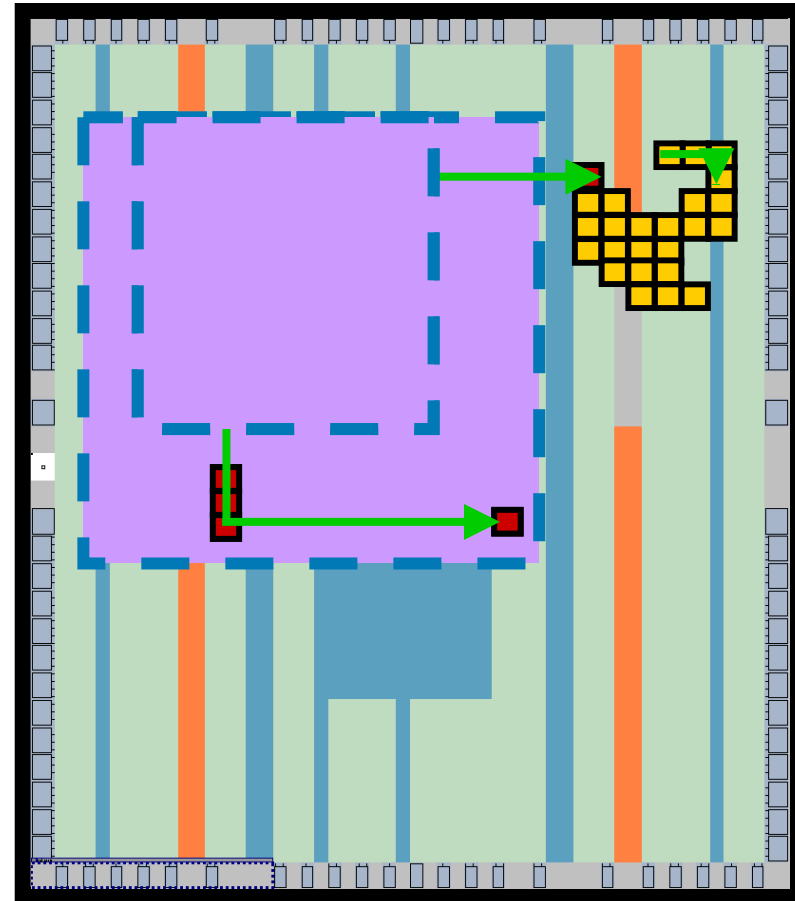

# Node Assignments

- Nodes Are Altera Specific Primitives
- Can Be Made Through
  - Assignment Organizer
  - Current Assignments Floorplan
  - Timing Closure Floorplan
  - Back-annotating Design

# Entity Assignments

- Modules of a Design
- Can Be Made Through
  - Assignment Organizer
  - Dragging and Dropping From Hierarchies Window to
    - Timing Closure Floorplan
    - LogicLock Regions Window

# Path-Based Assignments

- Can Only Be Made to LogicLock Regions
- Can Be Made:
  - Using New Path Window
  - By Dragging and Dropping Paths From Timing Analysis Section of Compilation Report
  - By Dragging and Dropping Using the Critical Paths Utility in the Timing Closure Floorplan

# Path-Based Assignments

- Assigns Every Path From Source & Destination Nodes
  - Nodes Source, N1, N2, N3, N4, Destination Will Be Assigned

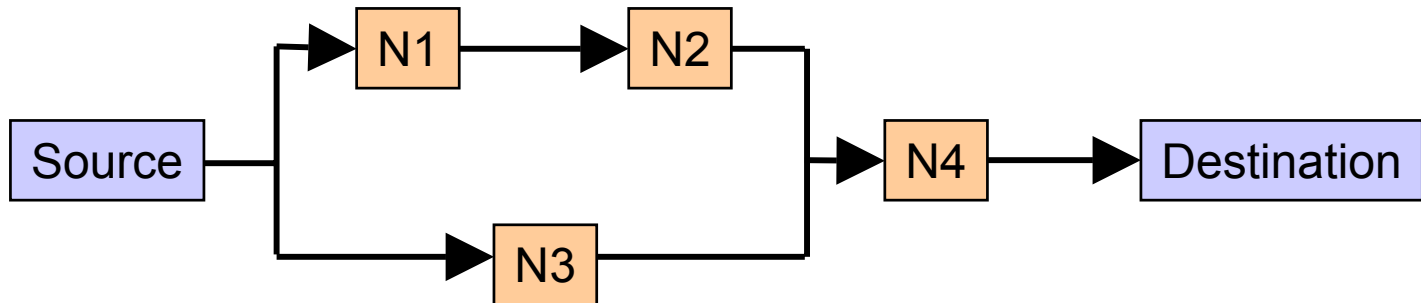

***What Nodes Shown If Using Critical Paths?***

# Path Window

- Allows Path to Be Specified Using Source & Destination
- Can Exclude Nodes
  - Source
  - Destination
  - Matching Wildcard
- Can Change LogicLock Region

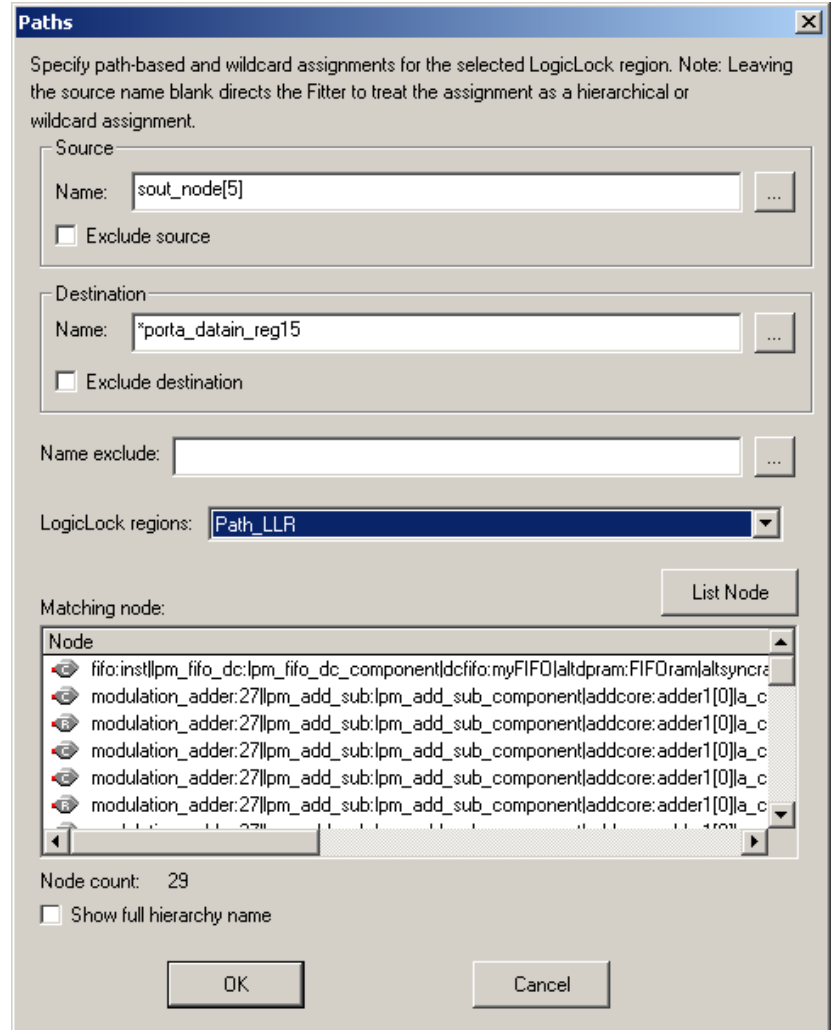



# Path Window

- List Node Lists Every Node to Which Assignment Will Apply
- Can Use \* & ? Wildcards in
  - Source Name
  - Destination Name
  - Name Exclude

***What Does \* Wildcard Do?***  
***What Does ? Wildcard Do?***

Paths

Specify path-based and wildcard assignments for the selected LogicLock region. Note: Leaving the source name blank directs the Fitter to treat the assignment as a hierarchical or wildcard assignment.

Source

Name:

Exclude source

Destination

Name:

Exclude destination

Name exclude:

LogicLock regions:

Matching node:

Node

- fifo:inst\lpm\_fifo\_dc:lpm\_fifo\_dc\_component\dcfifo:myFIFO\altdpram:FIFODram\altsyncr
- modulation\_adder:27\lpm\_add\_sub:lpm\_add\_sub\_component\addcore:adder1[0]a\_c
- modulation\_adder:27\lpm\_add\_sub:lpm\_add\_sub\_component\addcore:adder1[0]a\_c
- modulation\_adder:27\lpm\_add\_sub:lpm\_add\_sub\_component\addcore:adder1[0]a\_c
- modulation\_adder:27\lpm\_add\_sub:lpm\_add\_sub\_component\addcore:adder1[0]a\_c
- modulation\_adder:27\lpm\_add\_sub:lpm\_add\_sub\_component\addcore:adder1[0]a\_c

Node count: 29

Show full hierarchy name

# Path Window

- Can Access Path Window from

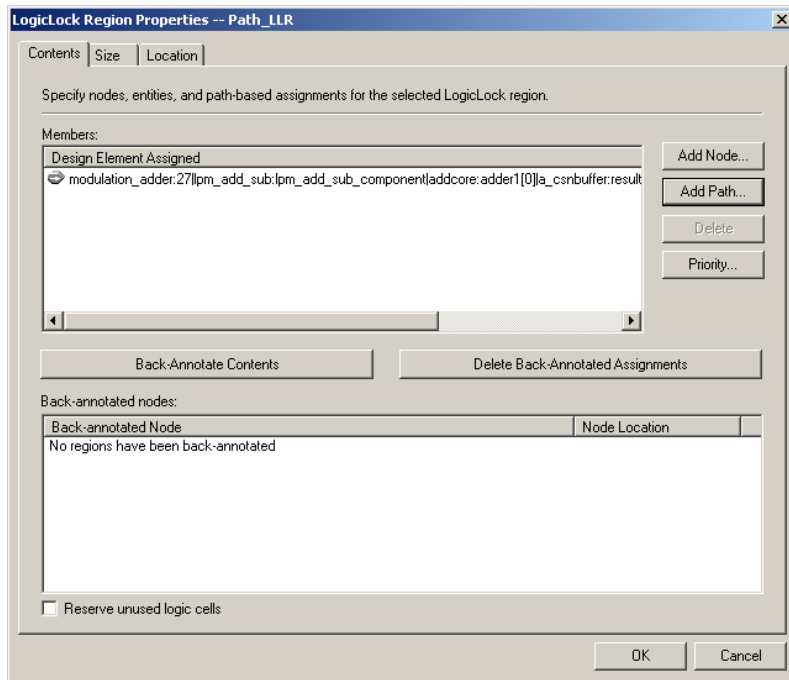

**LogicLock Regions  
Properties Window**

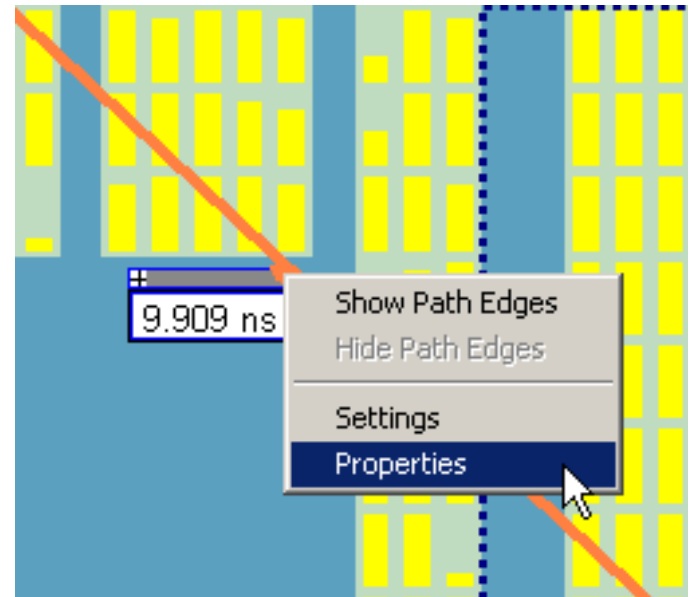

**Right Clicking on  
Critical Path**

# Priority of Assignments

- Need Way to Determine Priority of Nodes Assigned through Paths or Wildcards
- Priority Window

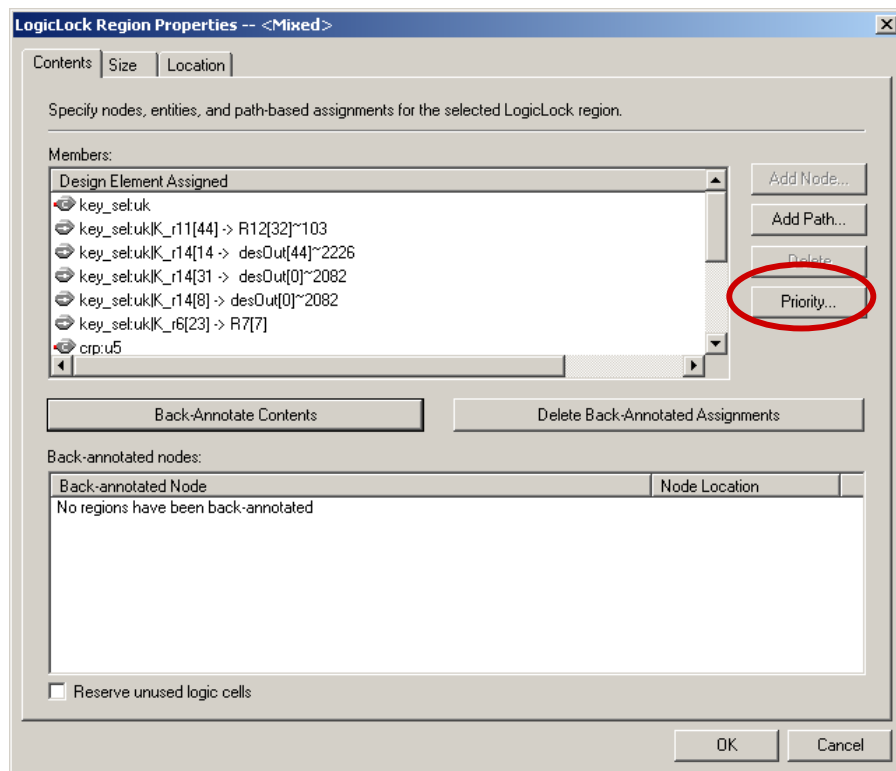
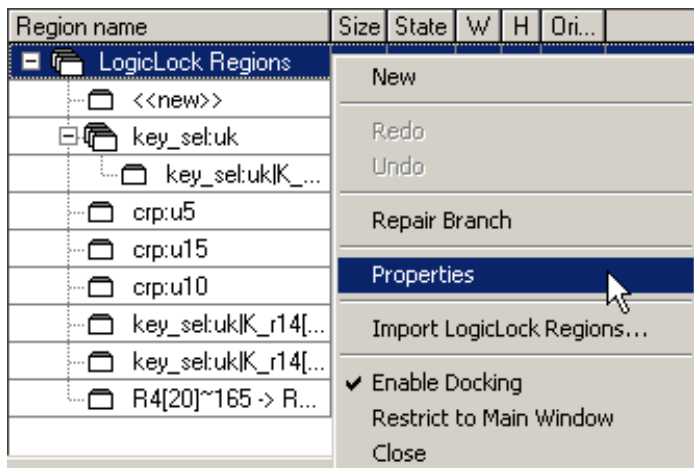

# Summary

- New Integrated Synthesis
- Now a Detailed Timing Closure Flow
- Netlist Optimization Options Available
- New Timing Closure Floorplan Tools for Design Analysis
- Making Assignments to Achieve Timing Closure